

Ryse Your Comfort



 **RYSE**
LIFT SOLUTIONS



www.ryselift.com.tr



ÖZDOĞRU

MÜHENDİSLİK



www.ozdogrumuhendislik.com

Firma Profili

1968 yılında, inşaat sektöründe Büyükbabamız EMİN RAŞİT ÖZDOĞRU' nun ÖZDOĞRU DEMİR SAN. TİC. LTD. ŞTİ. adıyla kireç, demir, çimento ve bilumum inşaat malzemeleri satışı ile hizmete başlayan aile şirketimiz, 1985 yılında Babamız HACI RAMAZAN ÖZDOĞRU kardeşleri EKREM VE EMİN ÖZDOĞRU ile ikinci şirketleri **ÖZDOĞRU İNŞAAT SAN. A.Ş.** yi kurmasıyla inşaat yapım, taahhüt ve müteahhitlik faaliyet alanlarını da hizmetleri arasına eklemiştir. 3 nesil Karaman'da sektörün liderliğini yapmanın haklı gururunu yaşamaktayız.

Ailenin 3. Nesil ferdi MEHMET MUHAMMET ÖZDOĞRU inşaat alanında ki uzun yıllar süren tecrübelerini eğitimi ile birleştirerek 2014 yılında **ÖZDOĞRU MÜHENDİSLİK SAN. VE TİC. LTD. ŞTİ.** yi kurmuş ve inşaat sektöründeki tecrübelerini inşaat sektörünün mekanik alanına taşımıştır. Firmamız Mekanik tesisat, Projelendirme, İklimlendirme, Isıtma-Soğutma ve Asansör montaj-bakım-yenileme alanlarında sektöre hizmet etmektedir. Firmamız dürüst çalışma anlayışı, yüksek müşteri memnuniyeti ile mükemmel hizmet anlayışını ilke edinmiş, her işte biraz bilgi sahibi olmak yerine kendi bildiği işte uzmanlaşıp tam verimli olma yolunu seçmiştir

Company Profile

*In 1968, our grandfather EMİN RAŞİT ÖZDOĞRU's ÖZDOĞRU DEMİR SAN. TİC. LTD. ŞTİ. Our family company started its service with the name of lime, iron, cement and all kinds of construction materials. **ÖZDOĞRU İNŞAAT SAN. A.Ş.** With the establishment of the company, they have added the fields of construction, contracting and contracting activities to their services. We are proud of being the leader of the sector in 3 generations Karaman.*

*The 3rd generation member of the family, MEHMET MUHAMMET ÖZDOĞRU, combined his long years of experience in the field of construction with his education and started **ÖZDOĞRU MÜHENDİSLİK SAN. VE TİC. LTD. ŞTİ.** and transferred its experience in the construction sector to the mechanical field of the construction industry. Our company serves the sector in the fields of Mechanical Installation, Projecting, Air Conditioning, Heating-Cooling and Elevator installation-maintenance-renewal. Our company has adopted the principle of honest working, high customer satisfaction and excellent service understanding, instead of having a little knowledge in every job, it has chosen the path to be fully efficient by specializing in its own work.*

İÇİNDEKİLER

CONTENT

MOTOR
MOTOR
MOTEUR
المحرك



KABİNER
CABINS
CABINES
الأكواخ



DESENLER
PATTERNS
MOTIFS
أنماط الزخارف



BUTONLAR
BUTONS
BOUTON
أزرار



ÖZDOĞRU
MÜHENDİSLİK



KONTROL PANELLERİ
CONTROL PANELS
PANNEAUX DE CONTRÔLE
لوحة تحكم

KAPILAR
DOORS
PORTES
الأبواب



ASANSÖR SİSTEMLERİ
ELEVATOR
SYSTEMS
SYSTÈMES
D'ASCENSEUR S
أنظمة المصاعد







KABINLER

CABINS | CABINES | خاكوالأ

OZD-01

YUNUS



TEKNİK ÖZELLİKLER

YAN DUVAR	RAL7032	Elektrostatik Boya
ARKA DUVAR	RAL7032	Elektrostatik Boya
AKSESUAR	RAL7032	Elektrostatik Boya
GÖNYE - BAŞLIK	RAL7032	Elektrostatik Boya
TABAN	PVC005	PVC Gri
TAVAN	CL 034	Elektrostatik Boya - Pleksi
AYDINLATMA	LED AMPL	Led Ampül
KÜPEŞTE	BPB-K	Paslanmaz - Arka I
AYNA	YBRL	Yarım Boy Rodajlı Lamine
STANDART	EN 81-20 • EN 81-70	

TECHNICAL SPECIFICATIONS

SIDE WALL	RAL7032	Electrostatic Painted
BACK WALL	RAL7032	Electrostatic Painted
ACCESSORY	RAL7032	Electrostatic Painted
ENTRANCE SIDES & HEADER	RAL7032	Electrostatic Painted
FLOOR	PVC005	PVC Grey
CEILING	CL 034	Electrostatic Painted Boya - Plexi
LIGHTING	LED AMPL	Led Bulb
HANDRAIL	BPB-K	Stainless Steel - Back I
MIRROR	YBRL	Half Length Grinding Laminated
STANDARD	EN 81-20 • EN 81-70	

OZD-02

MOZART



TEKNİK ÖZELLİKLER

YAN DUVAR	PSL001	Satine Paslanmaz
ARKA DUVAR	PSL001	Satine Paslanmaz
AKSESUAR	PSL001	Satine Paslanmaz
GÖNYE - BAŞLIK	PSL001	Satine Paslanmaz
TABAN	PVC005	PVC Gri
TAVAN	CL 034	Satine Paslanmaz - Pleksi
AYDINLATMA	LED AMPL	Led Ampül
KÜPEŞTE	BPB-K	Paslanmaz - Arka I
AYNA	YBRL	Yarım Boy Rodajlı Lamine
STANDART		EN 81-20 • EN 81-70

TECHNICAL SPECIFICATIONS

SIDE WALL	PSL001	Hairline Stainless Steel
BACK WALL	PSL001	Hairline Stainless Steel
ACCESSORY	PSL001	Hairline Stainless Steel
ENTRANCE SIDES & HEADER	PSL001	Hairline Stainless Steel
FLOOR	PVC005	PVC Grey
CEILING	CL 034	Hairline Stainless Steel - Plexi
LIGHTING	LED AMPL	Led Bulb
HANDRAIL	BPB-K	Stainless Steel - Back I
MIRROR	YBRL	Half Lenght Grinding Laminated
STANDARD		EN 81-20 • EN 81-70

OZD-03

CHOPIN



TEKNİK ÖZELLİKLER

YAN DUVAR	PSL001	Satine Paslanmaz
ARKA DUVAR	PSL001	Satine Paslanmaz
AKSESUAR	PSL001	Satine Paslanmaz
GÖNYE - BAŞLIK	PSL001	Satine Paslanmaz
TABAN	PVC005	PVC Gri
TAVAN	CL 051	Satine Paslanmaz - Pleksi
AYDINLATMA	LED AMPL	Led Ampül
KÜPEŞTE	BPB-K	Paslanmaz - Arka 1
AYNA	TBRL	Tam Boy Rodajlı Lamine
STANDART		EN 81-20 • EN 81-70

TECHNICAL SPECIFICATIONS

SIDE WALL	PSL001	Hairline Stainless Steel
BACK WALL	PSL001	Hairline Stainless Steel
ACCESSORY	PSL001	Hairline Stainless Steel
ENTRANCE SIDES & HEADER	PSL001	Hairline Stainless Steel
FLOOR	PVC005	PVC Grey
CEILING	CL 051	Hairline Stainless Steel - Plexi
LIGHTING	LED AMPL	Led Bulb
HANDRAIL	BPB-K	Stainless Steel - Back I
MIRROR	TBRL	Full Lenght Grinding Laminated
STANDARD		EN 81-20 • EN.81-70

OZD-04

BALZAC



TEKNİK ÖZELLİKLER

YAN DUVAR	PSL001	Satine Paslanmaz
ARKA DUVAR	PSL001	Satine Paslanmaz
AKSESUAR	DM-01	Dekoratif Paslanmaz
GÖNYE - BAŞLIK	DM-01	Dekoratif Paslanmaz
TABAN	BS 044	Kompoze Taş Nepilia
TAVAN	CL 034	Satine Paslanmaz - Pleksi
AYDINLATMA	LED AMPL	Led Ampül
KÜPEŞTE	BPB	Paslanmaz - Arka 1
AYNA	YBRL	Yarım Boy Rodajlı Lamine
STANDART		EN 81-20 • EN 81-70

TECHNICAL SPECIFICATIONS

SIDE WALL	PSL001	Hairline Stainless Steel
BACK WALL	PSL001	Hairline Stainless Steel
ACCESSORY	DM-01	Decorative Stainless Steel
ENTRANCE SIDES & HEADER	DM-01	Decorative Stainless Steel
FLOOR	BS 044	Artificial Stone Nepilia
CEILING	CL 034	Hairline Stainless Steel - Plexi
LIGHTING	LED AMPL	Led Bulb
HANDRAIL	BPB	Stainless Steel - Back 1
MIRROR	YBRL	Half Lenght Grinding Laminated
STANDARD		EN 81-20 • EN 81-70

OZD-05

BEETHOVEN



TEKNİK ÖZELLİKLER

YAN DUVAR	PSL001	Satine Paslanmaz
ARKA DUVAR	PSL001	Satine Paslanmaz
AKSESUAR	DM01	Dekoratif Paslanmaz
GÖNYE - BAŞLIK	PSL001	Satine Paslanmaz
TABAN	BS 039	Kompoze Taş Savana
TAVAN	CL 034	Satine Paslanmaz - Pleksi
AYDINLATMA	LED AMPL	Led Ampül
KÜPEŞTE	BPB	Paslanmaz - Arka I
AYNA	TBRL	Tam Boy Rodajlı Lamine
STANDART		EN 81-20 • EN 81-70

TECHNICAL SPECIFICATIONS

SIDE WALL	PSL001	Hairline Stainless Steel
BACK WALL	PSL001	Hairline Stainless Steel
ACCESSORY	DM-01	Decorative Stainless Steel
ENTRANCE SIDES & HEADER	PSL001	Hairline Stainless Steel
FLOOR	BS 039	Artificial Stone Savana
CEILING	CL 034	Elektrostatik Boya - Plexi
LIGHTING	LED AMPL	Led Bulb
HANDRAIL	BPB	Stainless Steel - Back I
MIRROR	TBRL	Full Lenght Grinding Laminated
STANDARD		EN 81-20 • EN 81-70

OZD-06

TESLA



TEKNİK ÖZELLİKLER

YAN DUVAR	PSL001	Satine Paslanmaz
ARKA DUVAR	PSL001	Satine Paslanmaz
AKSESUAR	PSL001	Satine Paslanmaz
GÖNYE - BAŞLIK	PSL001	Satine Paslanmaz
TABAN	PVC002	PVC Mavi
TAVAN	CL 027	Satine Paslanmaz - Pleksi
AYDINLATMA	LED AMPL	Led Ampül
KÜPEŞTE	BPB-K	Paslanmaz - Arka 1
AYNA	TBRL	Tam Boy Rodajlı Lamine
STANDART		EN 81-20 • EN 81-70

TECHNICAL SPECIFICATIONS

SIDE WALL	PSL001	Hairline Stainless Steel
BACK WALL	PSL001	Hairline Stainless Steel
ACCESSORY	PSL001	Hairline Stainless Steel
ENTRANCE SIDES & HEADER	PSL001	Hairline Stainless Steel
FLOOR	PVC002	PVC Blue
CEILING	CL 027	Hairline Stainless Steel - Plexi
LIGHTING	LED AMPL	Led Bulb
HANDRAIL	BPB-K	Stainless Steel - Back 1
MIRROR	TBRL	Full Lenght Grinding Laminated
STANDARD		EN 81-20 • EN 81-70

OZD-07

HAREZMİ



TEKNİK ÖZELLİKLER

YAN DUVAR	M13467	Laminant
ARKA DUVAR	M13467	Laminant
AKSESUAR	PSL001	Satine Paslanmaz
GÖNYE - BAŞLIK	PSL001	Satine Paslanmaz
TABAN	BS 037	Kompoze Taş Lebedos
TAVAN	CL 058	Satine Paslanmaz
AYDINLATMA	LS	Led Spot
KÜPEŞTE	BPB	Paslanmaz - Arka I
AYNA	YBRL	Yarım Boy Rodajlı Lamine
STANDART	EN 81-20 • EN 81-70	

TECHNICAL SPECIFICATIONS

SIDE WALL	M13467	Laminate
BACK WALL	M13467	Laminate
ACCESSORY	PSL001	Hairline Stainless Steel
ENTRANCE SIDES & HEADER	PSL001	Hairline Stainless Steel
FLOOR	BS 037	Artificial Stone Lebedos
CEILING	CL 058	Hairline Stainless Steel
LIGHTING	LS	Led Spot
HANDRAIL	BPB	Stainless Steel - Back I
MIRROR	YBRL	Half Lenght Grinding Laminated
STANDARD	EN 81-20 • EN 81-70	

OZD-08

ARISTO



TEKNİK ÖZELLİKLER

YAN DUVAR	M8814-2 MSM233	Laminant
ARKA DUVAR	M8814-2 MSM233	Laminant
AKSESUAR	PSL001	Satine Paslanmaz
GÖNYE - BAŞLIK	PSL001	Satine Paslanmaz
TABAN	BS005	Kompoze Taş
TAVAN	CL 034	Satine Paslanmaz - Pleksi
AYDINLATMA	LED AMPL	Led Ampül
KÜPEŞTE	BPB	Paslanmaz - Arka I
AYNA	TBRL	Tam Boy Rodajlı Lamine
STANDART		EN 81-20 • EN 81-70

TECHNICAL SPECIFICATIONS

SIDE WALL	M8814-2 MSM233	Laminate
BACK WALL	M8814-2 MSM233	Laminate
ACCESSORY	PSL001	Hairline Stainless Steel
ENTRANCE SIDES & HEADER	PSL001	Hairline Stainless Steel
FLOOR	BS005	Artificial Stone
CEILING	CL 034	Hairline Stainless steel - Plexi
LIGHTING	LED AMPL	Led Bulb
HANDRAIL	BPB	Stainless Steel - Back I
MIRROR	TBRL	Full Length Grinding Laminated
STANDARD		EN 81-20 • EN 81-70

OZD-09

DA VINCI



TEKNİK ÖZELLİKLER

YAN DUVAR	CR6027	RAL6027 Boyalı Cam
ARKA DUVAR	DM-01	Dekoratif Paslanmaz
AKSESUAR	DM-01	Dekoratif Paslanmaz
GÖNYE - BAŞLIK	DM-01	Dekoratif Paslanmaz
TABAN	BS005	Kompoze Taş
TAVAN	CL 050	Satine Paslanmaz
AYDINLATMA	LS	Led Spot
KÜPEŞTE	BPB	Paslanmaz - Arka I
AYNA	TBRL	Tam Boy Rodajlı Lamine
STANDART		EN 81-20 • EN 81-70

TECHNICAL SPECIFICATIONS

SIDE WALL	CR6027	RAL6027 Painted Glass
BACK WALL	DM-01	Decorative Stainless Steel
ACCESSORY	DM-01	Decorative Stainless Steel
ENTRANCE SIDES & HEADER	DM-01	Decorative Stainless Steel
FLOOR	BS005	Artificial Stone
CEILING	CL 050	Hairline Stainless Steel
LIGHTING	LS	Led Spot
HANDRAIL	BPB	Stainless Steel - Back I
MIRROR	TBRL	Full Lenght Grinding Laminated
STANDARD		EN 81-20 • EN 81-70

OZD-10

CURIE



TEKNİK ÖZELLİKLER

YAN DUVAR	RAL5014	Elektrostatik Boyalı
ARKA DUVAR	PSL001	Satine Paslanmaz
AKSEUAR	PSL001	Satine Paslanmaz
GÖNYE - BAŞLIK	PSL001	Satine Paslanmaz
TABAN	PVC005	PVC Gri
TAVAN	CL 034	RAL9003 Elektrostatik Boyalı - Pleksi
AYDINLATMA	LED AMPL	Led Ampül
KÜPEŞTE	BPB	Paslanmaz - Arka I
AYNA	TBRL	Tam Boy Rodajlı Lamine
STANDART		EN 81-20 • EN 81-70

TECHNICAL SPECIFICATIONS

SIDE WALL	RAL5014	Electrostatic Painted
BACK WALL	PSL001	Hairline Stainless Steel
ACCESSORY	PSL001	Hairline Stainless Steel
ENTRANCE SIDES & HEADER	PSL001	Hairline Stainless Steel
FLOOR	PVC005	PVC Grey
CEILING	CL 034	RAL9003 Electrostatic Painted - Plexi
LIGHTING	LED AMPL	Led Bulb
HANDRAIL	BPB	Stainless Steel - Back I
MIRROR	TBRL	Full Length Grinding Laminated
STANDARD		EN 81-20 • EN 81-70

OZD-11

ARCHIMED



TEKNİK ÖZELLİKLER

YAN DUVAR	PSL001	Satine Paslanmaz
ARKA DUVAR	RAL5008	Elektrostatik Boya
AKSESUAR	RAL5008	Elektrostatik Boya
GÖNYE - BAŞLIK	PSL001	Satine Paslanmaz
TABAN	PVC005	PVC Gri
TAVAN	CL 058	Satine Paslanmaz
AYDINLATMA	LS	Led Spot
KÜPEŞTE	BPB	Paslanmaz - Arka I
AYNA	TBRL	Tam Boy Rodajlı Lamine
STANDART		EN 81-20 • EN 81-70

TECHNICAL SPECIFICATIONS

SIDE WALL	PSL001	Hairline Stainless Steel
BACK WALL	RAL5008	Electrostatic Painted
ACCESSORY	RAL5008	Electrostatic Painted
ENTRANCE SIDES & HEADER	PSL001	Hairline Stainless Steel
FLOOR	PVC005	PVC Grey
CEILING	CL 058	Hairline Stainless Steel
LIGHTING	LS	Led Spot
HANDRAIL	BPB	Stainless Steel - Back I
MIRROR	TBRL	Full Length Grinding Laminated
STANDARD		EN 81-20 • EN 81-70

OZD-12

VAN GOGH



TEKNİK ÖZELLİKLER

YAN DUVAR	DJ005	Dijital Ahşap Kaplama
ARKA DUVAR	PSL001	Satine Paslanmaz
AKSEUAR	PSL001	Satine Paslanmaz
GÖNYE - BAŞLIK	PSL001	Satine Paslanmaz
TABAN	RAL5003	Boyalı Cam
TAVAN	CL 058	Satine Paslanmaz - Pleksi
AYDINLATMA	LS	Led Spot
KÜPEŞTE	BPB	Paslanmaz - Arka I
AYNA	TBRL	Tam Boy Rodajlı Lamine
STANDART	EN 81-20 • EN 81-70	

TECHNICAL SPECIFICATIONS

SIDE WALL	DJ005	Digital Printwood
BACK WALL	PSL001	Hairline Stainless Steel
ACCESSORY	PSL001	Hairline Stainless Steel
ENTRANCE SIDES & HEADER	PSL001	Hairline Stainless Steel
FLOOR	RAL5003	Painted Glass
CEILING	CL 058	Hairline Stainless Steel
LIGHTING	LS	Led Spot
HANDRAIL	BPB	Stainless Steel - Back I
MIRROR	TBRL	Full Lenght Grinding Laminated
STANDARD	EN 81-20 • EN 81-70	

OZD-13

HERCULES

AĞIR YÜK | HEAVY WEIGHT



TEKNİK ÖZELLİKLER

TECHNICAL SPECIFICATIONS

YAN DUVAR	RAL7032	Elektrostatik Boya	SIDE WALL	RAL7032	Electrostatic Painted
ARKA DUVAR	RAL7032	Elektrostatik Boya	BACK WALL	RAL7032	Electrostatic Painted
AKSEUAR	RAL7032	Elektrostatik Boya	ACCESSORY	RAL7032	Electrostatic Painted
GÖNYE - BAŞLIK	RAL7032	Elektrostatik Boya	ENTRANCE SIDES & HEADER	RAL7032	Electrostatic Painted
TABAN	BS 028	Gözyaşı Desenli Sac	FLOOR	BS 028	Checkered Plate
TAVAN	RAL7032	Elektrostatik Boya	CEILING	RAL7032	Electrostatic Painted
AYDINLATMA	LS	Led Spot	LIGHTING	LS	Led Spot
KÜPEŞTE	-	-	HANDRAIL	-	-
AYNA	-	-	MIRROR	-	-
STANDART	EN 81-20 • EN 81-70 (Opsiyonel)		STANDARD	EN 81-20 • EN 81-70 (Optional)	

OZD-14

HIPOKRAT

HASTANE | HOSPITAL



TEKNİK ÖZELLİKLER

TECHNICAL SPECIFICATIONS

YAN DUVAR	PSL001	Satine Paslanmaz	SIDE WALL	PSL001	Hairline Stainless Steel
ARKA DUVAR	PSL001	Satine Paslanmaz	BACK WALL	PSL001	Hairline Stainless Steel
AKSESUAR	PSL001	Satine Paslanmaz	ACCESSORY	PSL001	Hairline Stainless Steel
GÖNYE - BAŞLIK	PSL001	Satine Paslanmaz	ENTRANCE SIDES & HEADER	PSL001	Hairline Stainless Steel
TABAN	PVC 008	PVC Siyah	FLOOR	PVC 008	PVC Black
TAVAN	CL 036	Satine Paslanmaz	CEILING	CL 036	Hairline Stainless Steel
AYDINLATMA	LED AMPL	Led Ampül	LIGHTING	LED AMPL	Led Bulb
KÜPEŞTE	BPB-K	Paslanmaz - Arka 1	HANDRAIL	BPB-K	Stainless Steel - Back I
AYNA	YBRL	Yarım Boy Rodajlı Lamine	MIRROR	YBRL	Half Lenght Grinding Laminated
STANDART		EN 81-20 • EN 81-70	STANDARD		EN 81-20 • EN 81-70

OZD-15

PİSAGOR



TEKNİK ÖZELLİKLER

YAN DUVAR	PSL001	Satine Paslanmaz
ARKA DUVAR	PSL001	Satine Paslanmaz
AKSESUAR	PSL001	Satine Paslanmaz
GÖNYE - BAŞLIK	PSL001	Satine Paslanmaz
TABAN	PVC005	PVC / GRANİT
TAVAN	CL 034	Satine Paslanmaz - Plexi
AYDINLATMA	LED AMPL	Led Ampül
KÜPEŞTE	BPB-K	Paslanmaz - Arka I
AYNA	YBRL	Yarım Boy Rodajlı Lamine
STANDART		EN 81-20 • EN 81-70

TECHNICAL SPECIFICATIONS

SIDE WALL	PSL001	Hairline Stainless Steel
BACK WALL	PSL001	Hairline Stainless Steel
ACCESSORY	PSL001	Hairline Stainless Steel
ENTRANCE SIDES & HEADER	PSL001	Hairline Stainless Steel
FLOOR	PVC005	PVC Grey
CEILING	CL 034	Hairline Stainless Steel - Plexi
LIGHTING	LED AMPL	Led Bulb
HANDRAIL	BPB-K	Stainless Steel - Back I
MIRROR	YBRL	Half Length Grinding Laminated
STANDARD		EN 81-20 • EN 81-70

OZD-16

HAYYAM



TEKNİK ÖZELLİKLER

YAN DUVAR	PSL001	Satine Paslanmaz / AHŞAP
ARKA DUVAR	PSL001	Satine Paslanmaz / AHŞAP
AKSESUAR	PSL001	Satine Paslanmaz / AHŞAP
GÖNYE - BAŞLIK	PSL001	Satine Paslanmaz / AHŞAP
TABAN	PVC005	PVC Gri
TAVAN	CL 034	Satine Paslanmaz - Plexi
AYDINLATMA	LED AMPL	Led Ampül
KÜPEŞTE	BPB-K	Paslanmaz - Arka I
AYNA	YBRL	Yarım Boy Rodajlı Lamine
STANDART		EN 81-20 • EN 81-70

TECHNICAL SPECIFICATIONS

SIDE WALL	PSL001	Hairline Stainless Steel / WOODEN
BACK WALL	PSL001	Hairline Stainless Steel / WOODEN
ACCESSORY	PSL001	Hairline Stainless Steel / WOODEN
ENTRANCE SIDES & HEADER	PSL001	Hairline Stainless Steel / WOODEN
FLOOR	PVC005	PVC Grey
CEILING	CL 034	Hairline Stainless Steel - Plexi
LIGHTING	LED AMPL	Led Bulb
HANDRAIL	BPB-K	Stainless Steel - Back I
MIRROR	YBRL	Half Lenght Grinding Laminated
STANDARD		EN 81-20 • EN 81-70

OZD-G1

BATTUTA

PANORAMİK KABİN | PANORAMIC CABIN

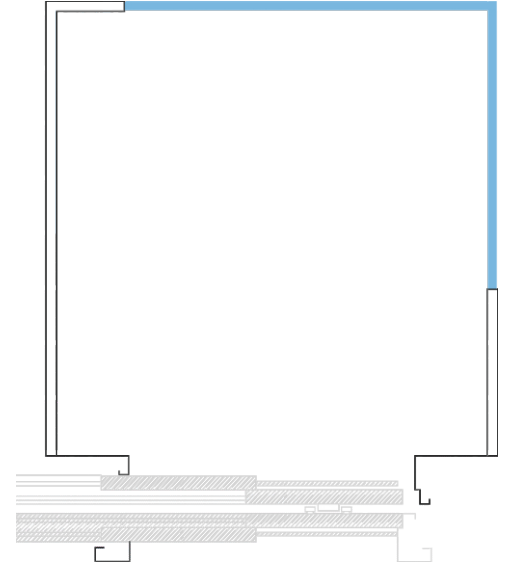

TEKNİK ÖZELLİKLER

KAPLAMA	PSL001	Satine Paslanmaz
AKSESUAR	DM-01	Dekoratif Paslanmaz
GÖNYE - BAŞLIK	PSL001	Satine Paslanmaz
TABAN	BS 044	Kompoze Taş Nepilia
TAVAN	PSL001	Satine Paslanmaz
AYDINLATMA	LS	Led Spot
KÜPEŞTE	BPB	Paslanmaz
STANDART		EN 81-20 • EN 81-70

TECHNICAL SPECIFICATIONS

COATING	PSL001	Hairline Stainless Steel
ACCESSORY	DM-01	Decorative Stainless Steel
ENTRANCE SIDES & HEADER	DM-01	Hairline Stainless Steel
FLOOR	BS 044	Artificial Stone Nepilia
CEILING	PSL001	Hairline Stainless Steel
LIGHTING	LS	Led Spot
HANDRAIL	BPB	Stainless Steel
STANDARD		EN 81-20 • EN 81-70

OZD-G2

PLATON

PANORAMİK KABİN | PANORAMIC CABIN

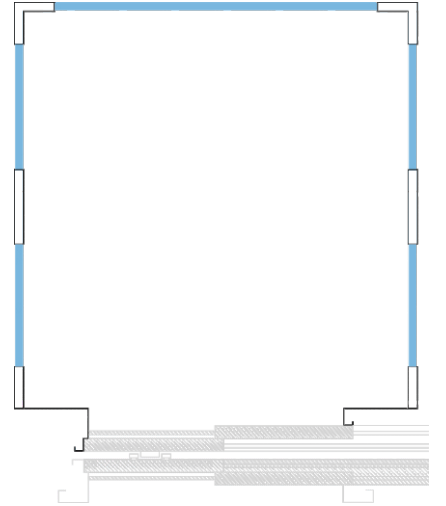

TEKNİK ÖZELLİKLER

KAPLAMA	PSL001	Satine Paslanmaz
AKSESUAR	PSL001	Satine Paslanmaz
GÖNYE - BAŞLIK	PSL001	Satine Paslanmaz
TABAN	BS 040	Kompoze Taş Smyrna
TAVAN	PSL001	Satine Paslanmaz
AYDINLATMA	LS	Led Spot
KÜPEŞTE	BPB	Paslanmaz
STANDART		EN 81-20 • EN 81-70

TECHNICAL SPECIFICATIONS

COATING	PSL001	Hairline Stainless Steel
ACCESSORY	PSL001	Hairline Stainless Steel
ENTRANCE SIDES & HEADER	PSL001	Hairline Stainless Steel
FLOOR	BS 040	Artificial Stone Symrna
CEILING	PSL001	Hairline Stainless Steel
LIGHTING	LS	Led Spot
HANDRAIL	BPB	Stainless Steel
STANDARD		EN 81-20 • EN 81-70

OZD-G3

PASCAL

PANORAMİK KABİN | PANORAMIC CABIN

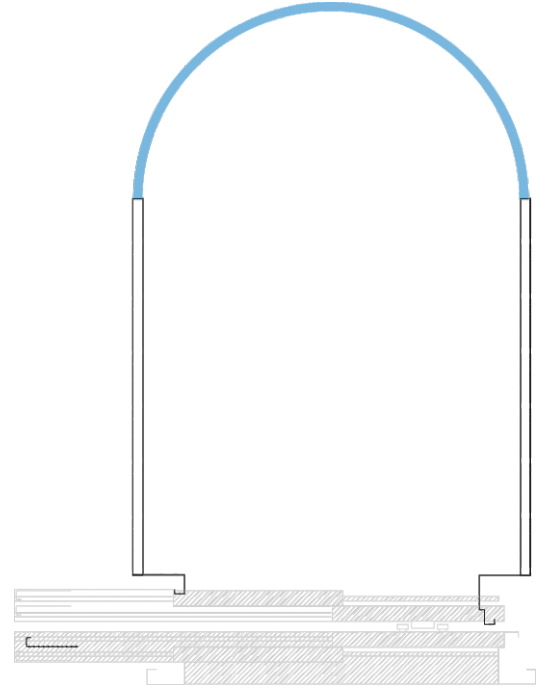

TEKNİK ÖZELLİKLER

KAPLAMA	PSL001	Satine Paslanmaz
AKSESUAR İÇ	DM-01	Dekoratif Paslanmaz
AKSESUAR DIŞ	DM-01	Dekoratif Paslanmaz (Opsiyonel)
GÖNYE - BAŞLIK	PSL001	Satine Paslanmaz
TABAN	BS 017	Doğal Taş
TAVAN	DM-01	Dekoratif Paslanmaz
AYDINLATMA	LS	Led Spot
KÜPEŞTE	BPB	Paslanmaz
STANDART		EN 81-20 • EN 81-70

TECHNICAL SPECIFICATIONS

COATING	PSL001	Hairline Stainless Steel
ACCESSORY INTERIOR	DM-01	Decorative Stainless Steel
ACCESSORY EXTERIOR	DM-01	Decorative Stainless Steel (Optional)
ENTRANCE SIDES & HEADER	PSL001	Hairline Stainless Steel
FLOOR	BS 017	Real Stone
CEILING	DM-01	Decorative Stainless Steel
LIGHTING	LS	Led Spot
HANDRAIL	BPB	Stainless Steel
STANDARD		EN 81-20 • EN 81-70



DESENLER

PATTERNS | MOTIFS | افراط الزخارف



CM - 01



CM - 02



CM - 03



CM - 04



CM - 05



CM - 06

CAM MODELİ

Glass Model / Modèle En Vere / نماذج زجاج المصاعد

DESENLER

Patterns | Motifs | انماط الزخارف



CM - 08



CM - 09



CM - 10



CM - 07



CM - 11



CM - 12

CAM MODELİ

Glass Model | Modèle En Vere | نماذج زجاج المصاعد



CM - 13



CM - 14



CM - 15



CM - 16

CAM MODELİ

Glass Model / Modèle En Vere / نماذج زجاج المصاعد

HIGH GLOSS | خشب هاي غلوس



HG - 201



HG - 202



HG - 203



HG - 204



HG - 205

Hg
Fantazi

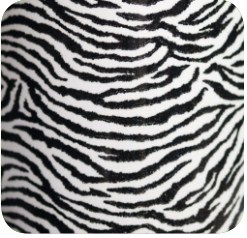

391

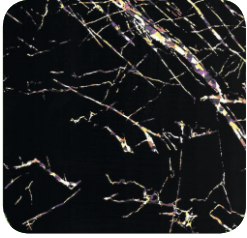

396



576



579

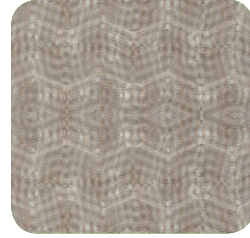

QUATRO

Hg
Hologram



MA - 401



MA - 402



MA - 403



MA - 404



MA - 405

Mat
Ahşap



MP - 501



MP - 502



MP - 503



MP - 504



MP - 505

Hg
Mat PVC

LAMİNANT | Lamine | Stratifié | صفح



L - 4255



L - 4279

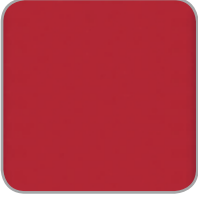

L - 3126



L - 4267



L - 4520



L - 4523



L - 4543

MEMBRAN | Membrane | Membrane | الغشائية



MB - 301



MB - 302

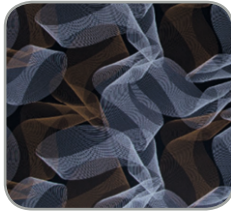

MB - 304



MB - 307



MB - 311



MB - 315

TAŞ DÖŞEME | Stone Pavement | Pavé De Pierre / أرضيات حجرية



TK - 201



TK - 202



TK - 203



TK - 204



TK - 205

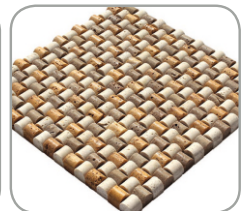

TK - 206

DESENLER

Patterns | Motifs | انماط الزخارف

PASLANMAZ SEÇENEKLERİ | Stainless Options Options Inoxydables | خيارات غير القابل للصدأ



ZEMİN SEÇENEKLERİ | Floor Options Options De Plancher | خيار الارضيات

PVC



PVC - 148



PVC - 149



PVC - 150



PVC - 151



PVC - 152



PVC - 153

GRANİT



G - 101



G - 102



G - 103

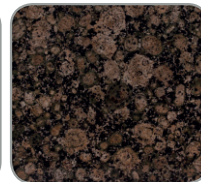

G - 106



G - 201



G - 204

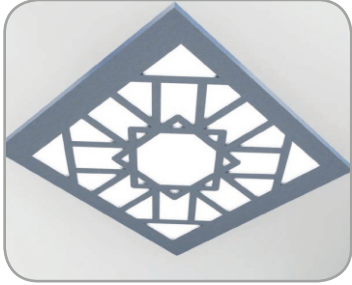

LV - 01

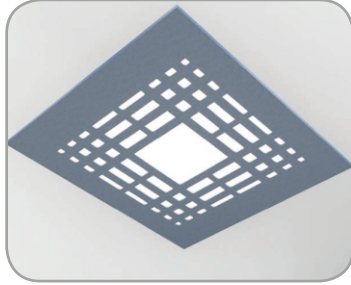

LV - 02

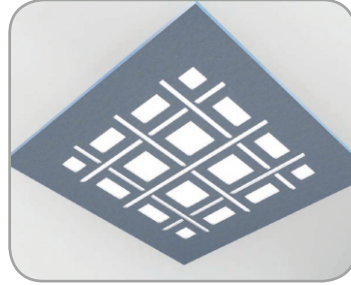

LV - 03



LV - 04



LV - 05



LV - 06

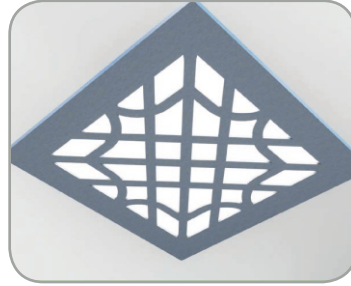

LV - 07



LV - 08

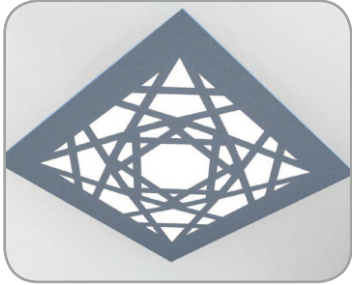

LV - 09



LV - 10

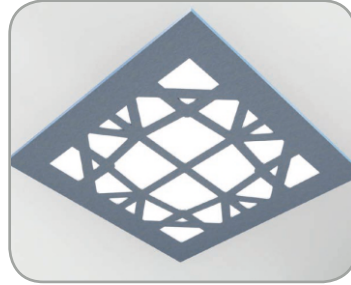

LV - 11



LV - 12

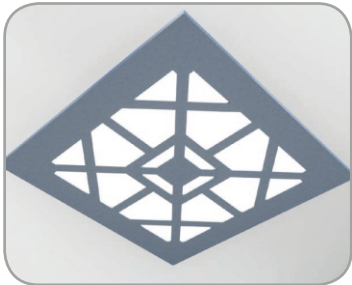

LV - 13



LV - 14



LV - 15



LV - 16

LAZER TAVAN

Laser Cutting Ceiling / Plafond
De Découpe Laser / سقف القطع بالليزر



LV - 17

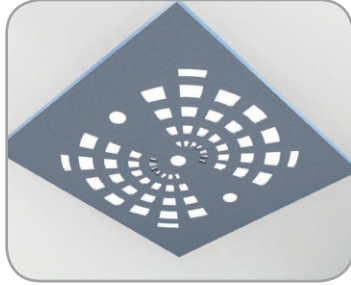

LV - 18

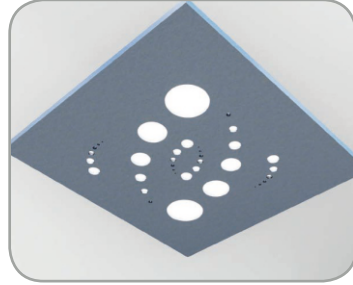

LV - 19



LV - 20



LV - 21



LV - 22

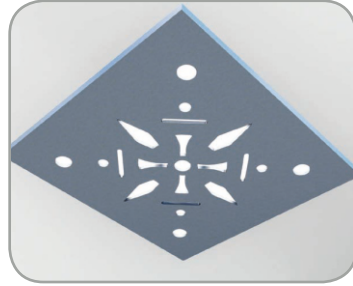

LV - 23



LV - 24

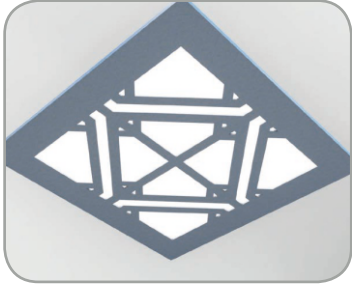

LV - 25



LV - 26

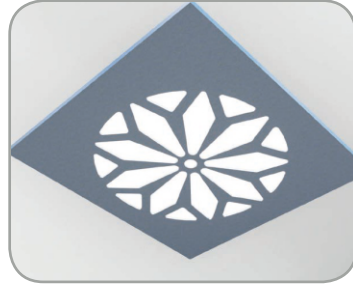

LV - 27

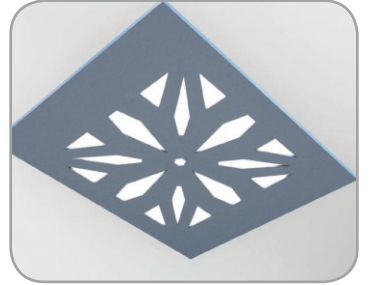

LV - 28



LV - 29

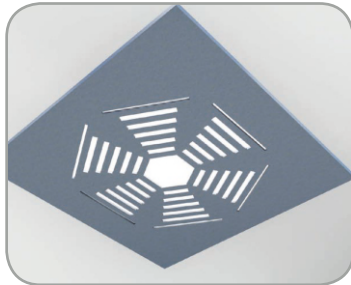

LV - 30

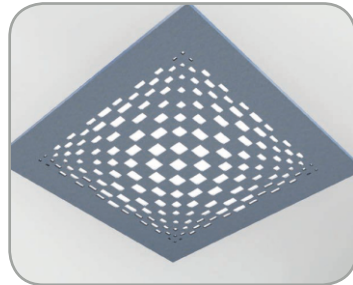

LV - 31



LV - 32

LAZER TAVAN

Laser Cutting Ceiling | Plafond
De Découpe Laser | سقف القطع بالليزر



ASANSÖR SİSTEMLER
ELEVATOR SYSTEMS | SYSTÈMES
D'ASCENSEUR S | أنظمة المصاعد

G TİP SÜSPANSİYON

G Type Suspension / Suspension
De Type G / ز نوع تعلیق



G TİP MRL SÜSPANSİYON

G Type Mrl Suspension / Suspension
De Type G Mrl / ز نوع تعلیق



ASANSÖR SİSTEMLERİ

Elevator Systems / Systèmes
D'ascenseur / أنظمة المصاعد

ÖZDOĞRU
MÜHENDİSLİK



L TİP SÜSPANSİYON

L Type Suspension / Suspension
De Type L / ل تعليق نوع

ASANSÖR SİSTEMLERİ

Elevator Systems / Systèmes
D'ascenseur / أنظمة المصاعد

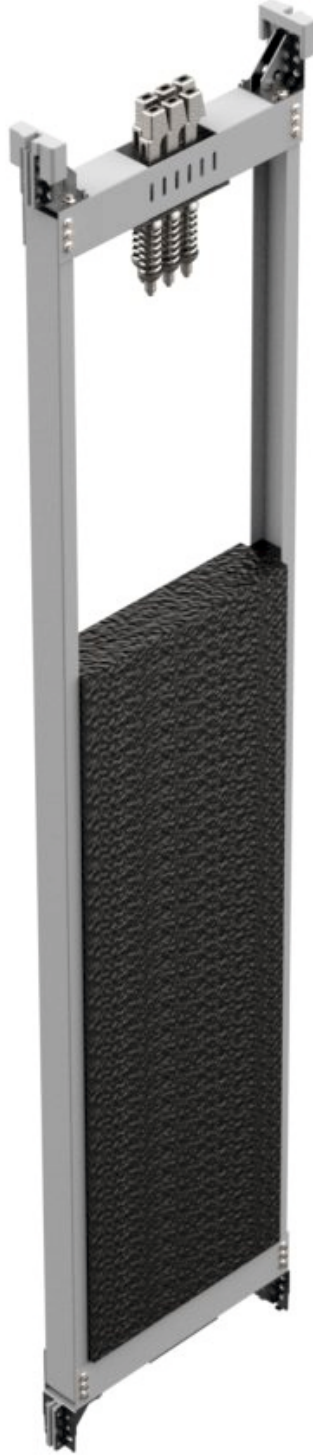

AĞIRLIK ŞASESİ

cwt frame / poids du châssis /
هيكل الوزن

MR SEHPA

MR Machine Frame / Mr - Cadre De La Machine

مر - إطار الجهاز



MRL SEHPA

MRL Machine Frame / mrl - Cadre De La Machine

مرل - إطار الجهاز

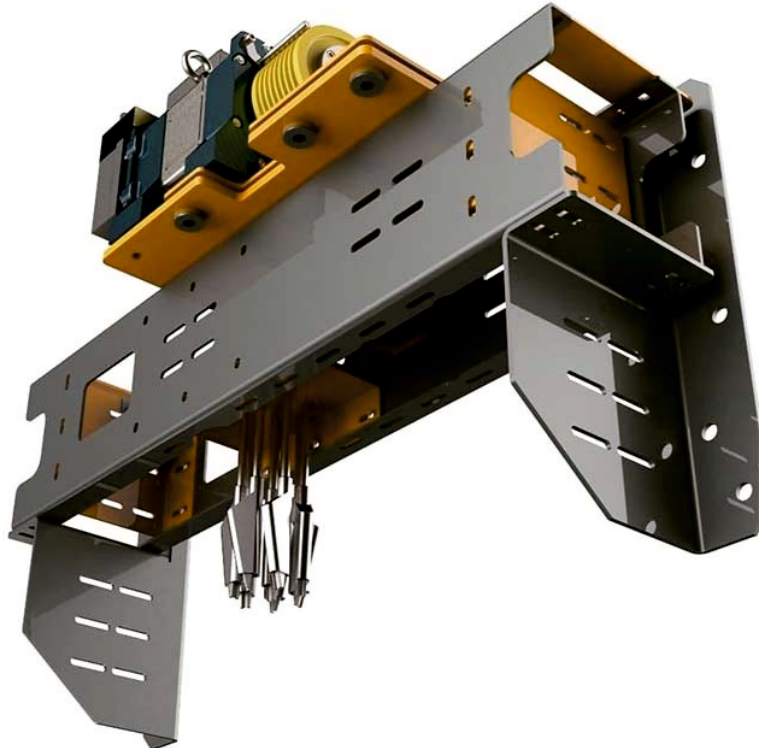

ASANSÖR SİSTEMLERİ

Elevator Systems / Systèmes
D'ascenseur / أنظمة المصاعد

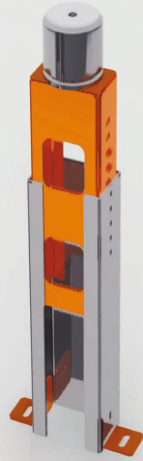
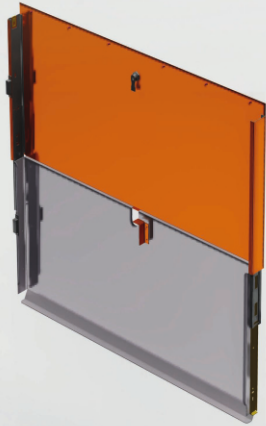
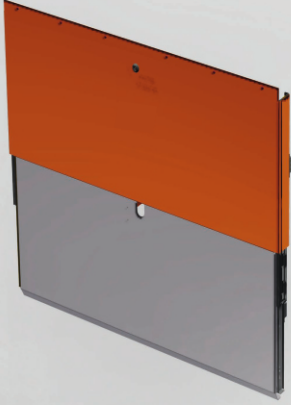

TELESKOPIK ETEK SACI

Folding Toe Guard / Garde -
Pieds Fixe / مصعد حماية الشريط

MERDİVEN

stairs / échelle / سلم

AYARLANABİLİR TAMPON SEHPASI

Adjustable buffer table / Table tam-
pon réglable / قابل للتعديل الجدول العازلة



TAM OTOMATİK ve
ÇARPMA KAPILAR
DOORS | PORTES | الأبواب

TAM OTOMATİK KAPILAR

Automatic Doors / Portes

Automatiques / الباب التلقائي



Satine Paslanmaz Otomatik Kat Kapısı

Satin Stainless Automatic Door

Porte Automatique En Inox Satiné

ابواب الساتان التلقائي غير قابل للصدأ

Dekoratif Paslanmaz Otomatik Kat Kapısı

Decorative stainless automatic door

Porte automatique inoxyidable et décorative

زخرفة الأبواب التلقائية غير قابلة للصدأ



Teleskobik 3 Panel Kat Kapısı
Telescopic 3 Panel Landing Door
Porte Télescopique à 3 Palières

باب مصعد خارجي جانبي ذو ثلاثة الواح

- *Her kanat her kasaya uyumlu
- *110 derece açılabilme imkanı
- *Gizli çelik menteşe ile yüksek taşıma kapasitesi
- *Son teknoloji ile el değmeden statik boyama sistemi
- *Karton ambalaj ile taşıma güvenliği

- *Each wing is suitable to each body*
- *110 degree opening possibility*
- *High carrying capacity with steel hinge*
- *Automatic Static painting system with latest technology*
- *Transporting security with carton packing*

- *Compatible à tous les cadres et battants*
- *Possibilité d'ouverture à 110 degrés*
- *Capacité de charge élevée avec charnière en acier*
- *Système automatique de peinture statique avec la dernière technologie*
- *Sécurité de transport avec emballage en carton*

كل جناح متوافق مع كل هيكل
إمكانية الفتح حتى 110 درجة
مفصلات فولاذية مخفية ذات قدرة تحمل عالية
نظام طلاء ثابت يمس بأحدث التقنيات
لسلامة النقل مغلفة بالكرتون



- *Her kanat her kasaya uyumlu
- *180 derece açılabilme imkanı
- *Çelik menteşe ile yüksek taşıma kapasitesi
- *Son teknoloji ile el değmeden statik boyama sistemi
- *Şirink ambalaj ile taşıma güvenliği
- *Kasa, kol, çerçeve bakır dövme
- *Kanat gümüş dövme

- *Each wing is suitable to each body
- *180 degree opening possibility
- *High carrying capacity with steel hinge
- *Automatic static painting system with latest technology
- *Transporting security with shrink packing
- *Body, arm, frame copper
- *Wing silver forging

- *Compatible à tous les cadres et battants
- *Possibilité d'ouverture à 180 degré
- *Capacité de charge élevée avec charnière en acier
- *Système automatique de peinture statique avec la dernière technologie
- *Sécurité de transport avec emballage sous vide
- *Cadre, bras, Charpente en cuivre
- *Battant forgé en argent

كل جناح متوافق مع كل حالة

إمكانية الفتح 180 درجة

قدرة حمولة عالية مع مفصلات فولاذية

نظام طلاء ثابت غير مألوف مع أحدث التقنيات

سلامة النقل مع تقليص التعبئة والتغليف حالة ، كم ،

نحاس إطار تزوير جناح الفضة





ÖZDOĞRU
MÜHENDİSLİK

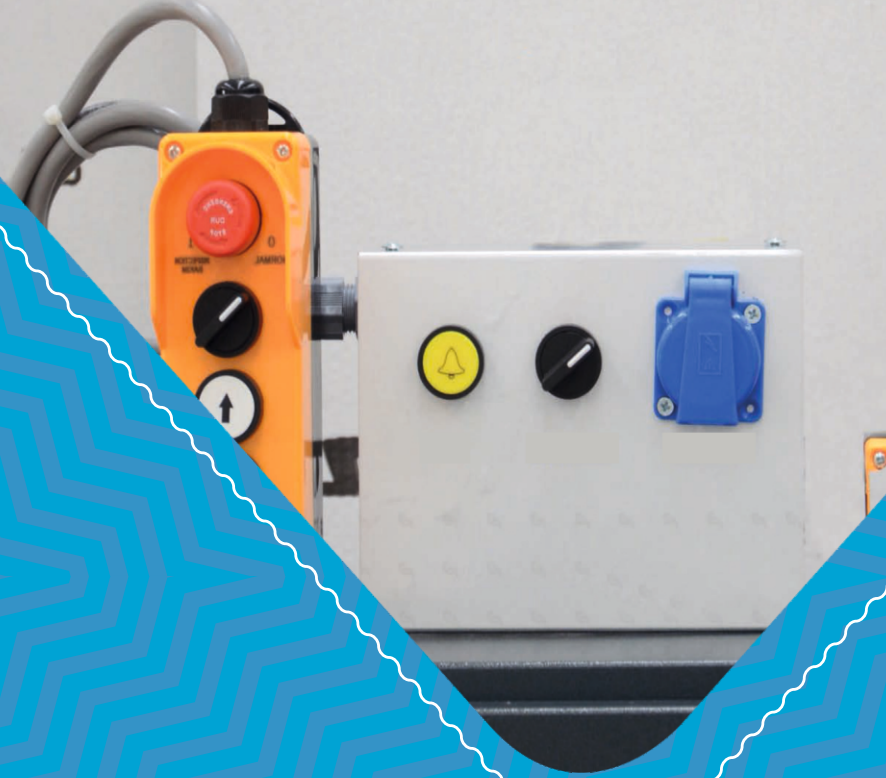

KONTROL PANELLERİ

CONTROL PANELS | PANNEAUX
DE CONTRÔLE | لوحة تحكم

KONTROL PANELLERİ

Control Panels | Panneaux De
Contrôle | لوحة تحكم

Revizyon Seti

Revision Set

مجموعة المراجع

Ensemble De
Révision



Arl 300 Kumanda Panosu

Arl 300 Control System

لوحة تحكم ARL 300

Système De Controle Arl 300

Arcode Kontrol Sistemi

Arcode Control System

نظام تحكم آلي اركودي

Système De Controle Arcode



BUTONLAR

BUTTONS | BOUTON | أزرار

BUTONLAR

Buttons | Bouton | أزرار





BUTONLAR

Buttons | Bouton | أزرار



BUTONLAR

Buttons | Bouton | أزرار



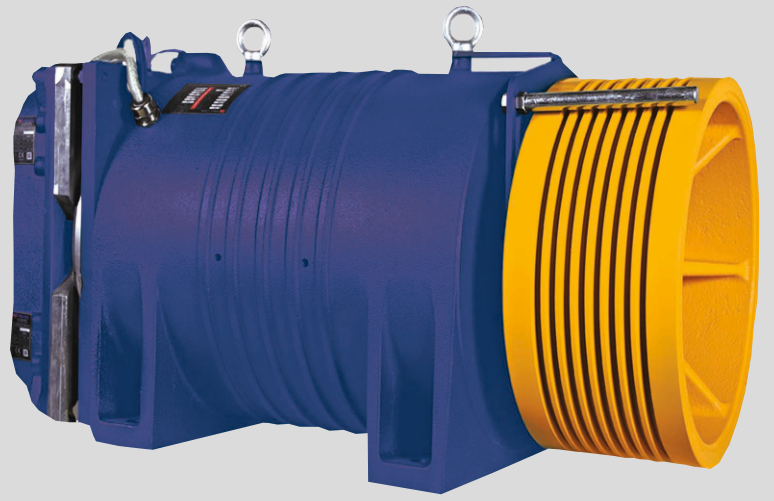

MOTOR

MOTOR | MOTEUR | المحرك

VVVF



MRL

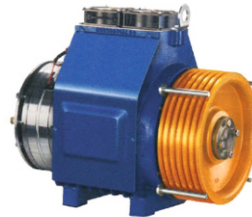
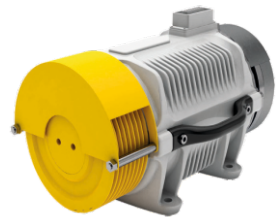

KP 901

KAPALI TİP PLATFORM
ENCLOSED PLATFORM LIFT

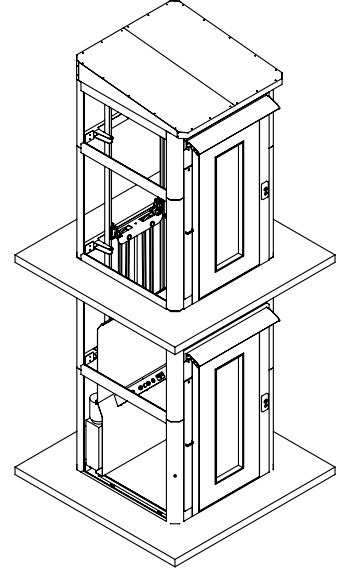
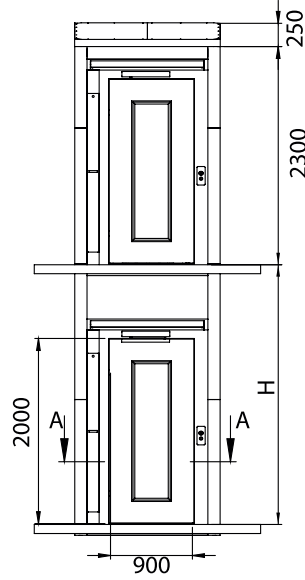

**Kuyu gerektirmemesi sayesinde,
her alana kolay ve sorunsuz kurulum**

Easy and trouble-free installation in any area as it does not require a pit



Geniş kullanım alanına sahiptir. Tahrik sistemi hidrolik ve sonsuz mil teknolojisi ile mümkündür. İç ve dış mekanlarda güvenle ve emniyetle kullanılabilir. Kuyu gerektirmemesi sayesinde her alana kolay ve sorunsuz kurulum olur. Büyük yapısal değişikliklere gerek duyulmaz. Genellikle 4 durağa kadar olan yerlerde kullanılan bu platformlar katlı yapıları, bireyler için sorun olmaktan çıkartır.

Kullanım alanları, Okul, Camii, Karakol, Rehabilitasyon Merkezleri, Kamu Kurumları, Otel, Sağlık Kuruluşları, Eğitim Merkezleri, Site Alanları ve vb. yerlerde tercih edilir. KP 901 modeli 2006/42/AT yönetmelikleri standartları dahilinde üretilir ve CE işareti ile piyasaya arz edilir. Kullanıcı ve çevre güvenliği en üst düzeyde tutulmuştur.

This model has wide area of usage. Driving system of the lift hydraulic and worm shaft. It can be used safely and meet your requirements indoors and outdoors The lift is easy to install and can be placed directly onto the floor, not required pit. It does not need extra construction during the installation. It has 4 stops and helps to customer not to waste time. The outdoor lift is equipped to resist to extreme weather conditions.

Area of usage: Schools, Temples, Police stations, Rehabilitation centers, Public institutions, Private health institutions, Training centers. KP 901 model is produced within the standards of 2006/42 / EC regulations and supplied to the market with CE certificate. User and environment safety are in the highest level.



TEKNİK ÖZELLİKLER | TECHNICAL SPECIFICATIONS

Tahrik Tipi Drive Type	Hidrolik / Vidalı Sistem Hydraulic / Worm Screw
Taşıma Kapasitesi Load Capability	315 / 400 kg 315 / 400 kg
Max Seyir Mesafesi Distance	15 mt 15 mt
Çalışma Hızı Speed	0,15 mt/sn 0,15 mt/sec
Platform İç Ölçüleri Platform Internal Dimensions	1100*1400 mm / (Özel Ölçü) 1100*1400 mm / (Special Dimension)
Platform Dış Ölçüleri Platform External Dimensions	1600*1600 mm / (Özel Ölçü) 1600*1600 mm / (Special Dimension)
Kuyu Dibi Pit	120 mm – 150 mm – 250 mm 120 mm – 150 mm – 250 mm
Kapı Door	Tam Otomatik Fully Automatic
Acil Kurtarma Sistemi Emergency Rescue System	Ups / Manuel Ups / Manual
Anons Sistemi Announcement System	3 Dil / Türkçe-İngilizce-Arapça 3 Languages / Turkish, English, Arabic
İntercom Sistemi Intercom System	Var Available
Ana Güç Gereksinimi Main power requirement	220 V AC - 50 Hz - Monofaze / 380 V AC - 50 Hz -Trifaze 220 V AC - 50 Hz - Monofaze / 380 V AC - 50 Hz -Three Phase

KP 901

KAPALI TİP PLATFORM ENCLOSED PLATFORM LIFT

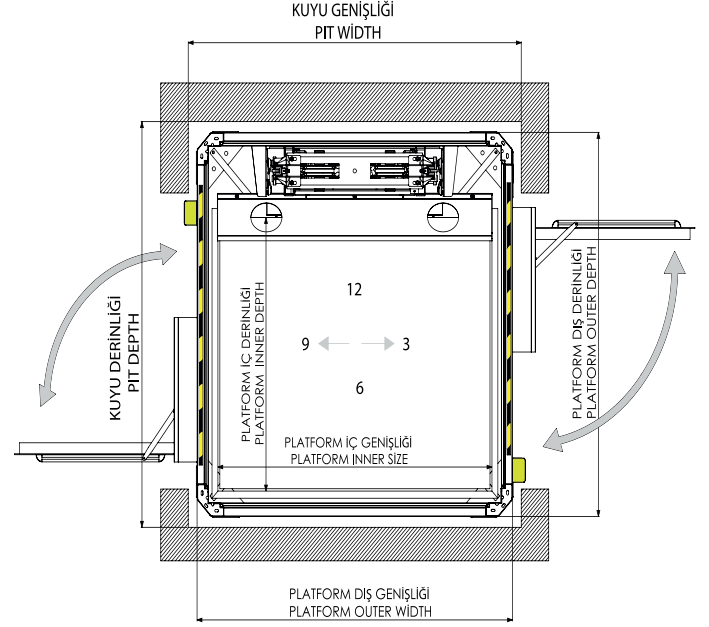
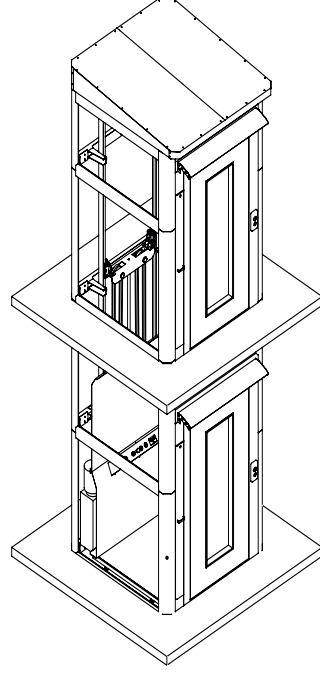
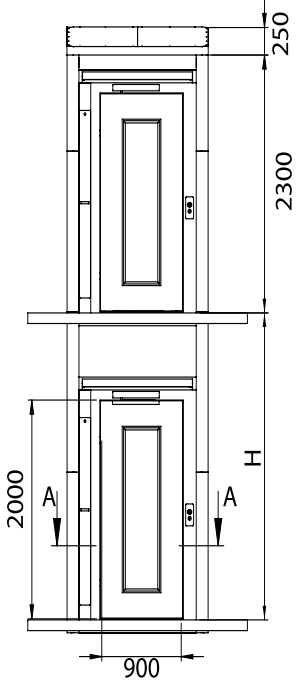

KABİN YÜKSEKLİĞİ

CABIN HEIGHT

2.500 mm



KURULUM

INSTALLATION

3-4 Günde Kurulum
In 3-4 Days



GÜÇ

POWER SUPPLY

220 - 380 v (AC)



HIZ

TOTAL SPEED

0,15 m/s



GARANTİ

GUARANTEE

2 Yıl / Years



KAT SAYISI

FLOOR NUMBER

6



MOTOR SİSTEMİ

DRIVE SYSTEM

Hidrolik - Vidalı

Hydraulic - Screw



YOLCULUK MESAFESİ

TRAVEL HEIGHT

15 m



KABİN SEÇENEKLERİ

CABIN OPTIONS

- Platform

- Asansör Kabini / Elevator Cabin

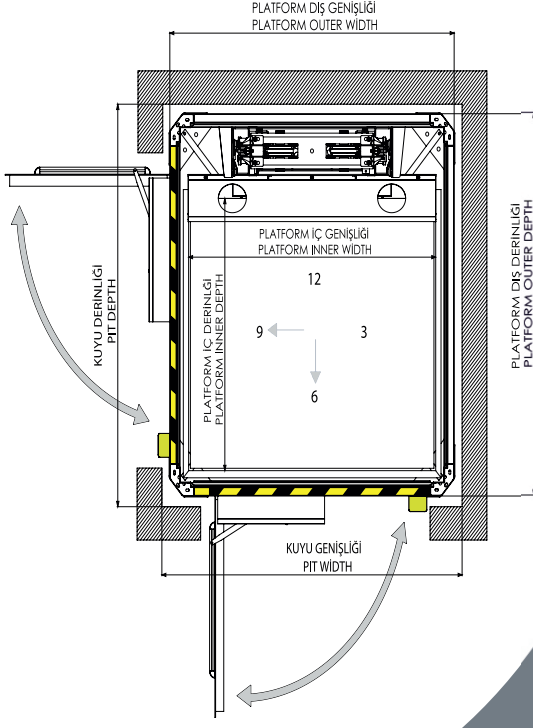

CAM RENK SEÇENEKLERİ GLASS COLOR OPTIONS



Normal Cam
Transparent Glass



Mavi
Blue Glass



Füme
Fume Glass



Bronz
Bronze Glass

PROFİL ÖZELLİKLERİ ELEVATOR STRUCTURE TYPE

- RAL Boyalı / RAL Paint

PROFİL RENK SEÇENEKLERİ ELEVATOR STRUCTURE COLOR



RAL 7012



RAL 7016



RAL 7032



RAL 7035



RAL 9005



RAL 9016

KAPI ÖZELLİKLERİ DOOR TYPE

- Dairesel Otomatik/ Circleslide Automatic
Door

- Teleskopik Kapı / Telescopic Door

- Manuel Kapı / Manual Door



— REFERANSLARIMIZ —



Cüvenle
Yükselin!



ÖZDOĞRU
MÜHENDİSLİK
SANAYİ VE TİCARET LİMİTED ŞİRKETİ



ÖZDOĞRU MÜHENDİSLİK
SANAYİ VE TİCARET LİMİTED ŞİRKETİ

 **+90 (338) 213 70 70**

 İmaret Mah. Atatürk Blv. 154. Sk. No: 2/F - KARAMAN

 iletisim@ozdogrumuhendislik.com

 www.ozdogrumuhendislik.com